

Bourdon tube pressure gauge, stainless steel XSEL[®] process pressure gauge Models 232.34 and 233.34, NS 4 1/2" and 6"

WIKA data sheet PM 02.10



For further approvals,
see page 5



Applications

- For applications with highly dynamic pressure loads and vibrations
- For gaseous and liquid aggressive media that are not highly viscous or crystallising, also in aggressive environments
- Process industry: Plant construction, chemical industry, petrochemical industry, power plants, mining, on-/offshore and environmental technology
- Machine building and general plant construction

Special features

- Excellent load-cycle stability and shock resistance
- Safety version with solid baffle wall designed in compliance with the requirements and test conditions of ASME B 40.100
- With case filling (model 233.34) for applications with high dynamic pressure loads and vibrations
- Scale ranges from 0 ... 10 to 0 ... 30,000 psi [0 ... 0.6 to 0 ... 2,000 bar]
- QR code on dial links to instrument-specific information

Description

This high-quality Bourdon tube pressure gauge has been designed especially for the process industry.

The use of high-quality materials and the robust design are geared to applications in the chemical and process engineering industries.

Scale ranges of 0 ... 10 to 0 ... 30,000 psi [0 ... 0.6 to 0 ... 2,000 bar] ensure the measuring ranges required for a wide variety of applications.

WIKA manufactures and qualifies the pressure gauge in accordance with the standard ASME B40.100. As a safety function, this instrument has a solid baffle wall with blow-out back.



Bourdon tube pressure gauge, model 232.34, NS 4 1/2"

In the event of a failure, the operator is protected at the front side, as media or components can only be ejected via the back of the case. The glass-fibre reinforced PBT case offers the necessary stability for reproducible measurements, even under aggressive ambient conditions.

With the model 233.34, the case filling in combination with a screwed-in restrictor enables use in applications with highly dynamic pressure loads and vibrations.

The QR code on the dial allows instrument-specific information such as the serial number, the order number, certificates and other product data to be retrieved from the internet easily and in the long term.

Specifications

Basic information	
Standard	ASME B40.100
Special design feature	<ul style="list-style-type: none"> ■ Without ■ For oxygen service, cleanliness per ASME B40.1 level IV ■ Silicone-oil-free version ■ Per NACE ¹⁾ MR0175 / ISO 15156, use in H₂S-containing environments in oil and gas production
Nominal size (NS)	<ul style="list-style-type: none"> ■ 4 ½" [115 mm] ■ 6" [160 mm]
Connection location	<ul style="list-style-type: none"> ■ Lower mount (radial) ■ Lower back mount
Window	Sealing from NBR
4 ½" [115 mm]	<ul style="list-style-type: none"> ■ Plastic, crystal-clear, non-splintering ■ Laminated safety glass ■ Instrument glass
6" [160 mm]	<ul style="list-style-type: none"> ■ Laminated safety glass ■ Plastic, crystal-clear, non-splintering ■ Instrument glass
Case	
Design	With solid baffle wall (Solidfront) and blow-out back
Internal pressure compensation ²⁾	<ul style="list-style-type: none"> ■ With diaphragm ■ Without
Material	PBT thermoplastic, glass-fibre reinforced, black ³⁾
Ring	Threaded bezel, PBT thermoplastic, glass-fibre reinforced, black ³⁾
Mounting	<ul style="list-style-type: none"> ■ Surface mounting flange (integrated into case) ■ Adapter kit for panel mounting incl. front bezel from polished stainless steel ⁴⁾
Case filling (model 233.34)	<ul style="list-style-type: none"> ■ Without ■ Glycerine ■ Glycerine-water mixture for scale ranges ≤ 0 ... 40 psi [≤ 0 ... 2.5 bar] ■ Silicone oil ■ Halocarbon oil
Movement	<ul style="list-style-type: none"> ■ Stainless steel ■ Stainless steel, dampened with silicone oil
	Internal movement stop set at 1.1-fold full scale value

1) General information about NACE standards; see technical information IN 00.21

2) Filled instruments or instruments with radial lower mount connection are always equipped with a diaphragm for internal pressure compensation

3) Case and ring also available in red or yellow (only for NS 4 ½" [115], lower mount (radial))

4) Only available for NS 4 ½" [115]

Measuring element	
Type of measuring element	Bourdon tube, C-type or helical type
Material	Stainless steel 316L

Accuracy specifications	
Accuracy class	±0.5 % of measuring span (grade 2A) ¹⁾
Temperature error	On deviation from the reference conditions at the measuring system: ≤ ±0.4 % per 18 °F [≤ ±0.4 % per 10 °C] of full scale value
Reference conditions	
Ambient temperature	+68 °F [+20 °C]

1) ±1 % of measuring span (grade 1A) for scale range ≥ 0 ... 20,000 psi [0 ... 1,600 bar]

Scale ranges, gauge pressure

psi	
0 ... 10	0 ... 1,000
0 ... 15	0 ... 1,500
0 ... 30	0 ... 2,000
0 ... 60	0 ... 3,000
0 ... 100	0 ... 5,000
0 ... 160	0 ... 10,000
0 ... 200	0 ... 15,000
0 ... 300	0 ... 20,000
0 ... 400	0 ... 30,000 ¹⁾
0 ... 600	-

bar	
0 ... 0,6	0 ... 60
0 ... 1	0 ... 100
0 ... 1.6	0 ... 160
0 ... 2.5	0 ... 250
0 ... 4	0 ... 400
0 ... 6	0 ... 600
0 ... 10	0 ... 1,000
0 ... 16	0 ... 1,600
0 ... 25	0 ... 2,000 ¹⁾
0 ... 40	-

kPa	
0 ... 60	0 ... 6,000
0 ... 100	0 ... 10,000
0 ... 160	0 ... 16,000
0 ... 250	0 ... 25,000
0 ... 400	0 ... 40,000
0 ... 600	0 ... 60,000
0 ... 1,000	0 ... 100,000
0 ... 1,600	0 ... 160,000
0 ... 2,500	0 ... 200,000 ¹⁾
0 ... 4,000	-

MPa	
0 ... 0.06	0 ... 6
0 ... 0.1	0 ... 10
0 ... 0.16	0 ... 16
0 ... 0.25	0 ... 25
0 ... 0.4	0 ... 40
0 ... 0.6	0 ... 60
0 ... 1.0	0 ... 100
0 ... 1.6	0 ... 160
0 ... 2.5	0 ... 200 ¹⁾
0 ... 4	-

1) Only available with a G ½ B or a high-pressure process connection (e.g. Autoclave Engineering)

Vacuum and +/- scale ranges

psi	
-30 inHg ... 0	-30 inHg ... +100
-30 inHg ... +15	-30 inHg ... +160
-30 inHg ... +30	-30 inHg ... +200
-30 inHg ... +60	-30 inHg ... +300

bar	
-1 ... 0	-1 ... +5
-1 ... +0.6	-1 ... +9
-1 ... +1.5	-1 ... +15
-1 ... +3	-1 ... +24

kPa	
-100 ... 0	-100 ... +500
-100 ... +60	-100 ... +900
-100 ... +150	-100 ... +1,500
-100 ... +300	-100 ... +2,400

MPa	
-0.1 ... 0	-0.1 ... +0.5
-0.1 ... +0.06	-0.1 ... +0.9
-0.1 ... +0.15	-0.1 ... +1.5
-0.1 ... +0.3	-0.1 ... +2.4

→ Other scale ranges and units on request

Further details on: Scale ranges

Unit

- psi
- bar
- kg/cm²
- kPa
- MPa

Further details on: Scale ranges	
Increased overload safety	<ul style="list-style-type: none"> ■ Without ■ 2-fold ■ 3-fold ■ 4-fold ■ 5-fold <p>The possibility of selection depends on the scale range</p>
Vacuum resistance	<ul style="list-style-type: none"> ■ Without ■ Vacuum-resistant to -1 bar
Dial	
Scale colour	Black
Material	Aluminium
Customer-specific version	<ul style="list-style-type: none"> ■ Without ■ Reflecting dial background with InSight™ printing (e.g. white, yellow/green or glow-in-the-dark dial) <p>→ Other scales, e.g. with red mark, circular arcs or circular sectors, on request</p>
Pointer	
Instrument pointer	Adjustable pointer, aluminium, black
Mark pointer/drag pointer	<ul style="list-style-type: none"> ■ Without ■ Red drag pointer on window, resetting with fixed adjustment key ■ Red drag pointer on window, resetting with removable adjustment key
Pointer stop pin	At 6 o'clock

Process connection	
Standard	<ul style="list-style-type: none"> ■ ANSI/ASME B1.20.1 ■ EN 837-1
Size	
ANSI/ASME B1.20.1	<ul style="list-style-type: none"> ■ ¼ NPT, male thread ■ ½ NPT, male thread
EN 837-1	<ul style="list-style-type: none"> ■ G ¼ B, male thread ■ G ½ B, male thread
Restrictor	<ul style="list-style-type: none"> ■ Ø 0.6 mm [0.024"], stainless steel ■ Ø 0.3 mm [0.012"], stainless steel
Material (wetted)	
Process connection	Stainless steel 316L
Bourdon tube	Stainless steel 316L



→ Other process connections on request

Operating conditions							
Medium temperature							
With glycerine filling	-4 ... +212 °F [-20 ... +100 °C]						
Unfilled instruments or with silicone oil filling	-40 ... +212 °F [-40 ... +100 °C]						
Ambient temperature							
With glycerine filling	-4 ... +140 °F [-20 ... +60 °C]						
Unfilled instruments or with silicone oil filling	-40 ... +140 °F [-40 ... +60 °C]						
Pressure limitation	<table border="1" style="width: 100%; border-collapse: collapse;"> <tr> <td>Steady</td> <td>Full scale value</td> </tr> <tr> <td>Fluctuating</td> <td>0.9 x full scale value</td> </tr> <tr> <td>Short time</td> <td>1.5 x full scale value ¹⁾</td> </tr> </table>	Steady	Full scale value	Fluctuating	0.9 x full scale value	Short time	1.5 x full scale value ¹⁾
Steady	Full scale value						
Fluctuating	0.9 x full scale value						
Short time	1.5 x full scale value ¹⁾						
Ingress protection ²⁾	<ul style="list-style-type: none"> ■ IP54 per EN/IEC 60529 ■ IP65 per EN/IEC 60529 						



1) 1,0 x full scale value for scale ranges > 10,000 psi [690 bar]

2) Filled instruments or instruments with radial lower mount connection always fulfil IP65 ingress protection

Approvals

Logo	Description	Region
	EU declaration of conformity Pressure equipment directive PS > 200 bar, module A, pressure accessory	European Union
	UKCA Pressure equipment (safety) regulations	United Kingdom
-	CRN Safety (e.g. electr. safety, overpressure, ...) For scale ranges ≤ 1,000 bar	Canada

Optional approvals

Logo	Description	Region
	PAC Kazakhstan Metrology, measurement technology	Kazakhstan
-	MChS Permission for commissioning	Kazakhstan
-	PAC Ukraine Metrology, measurement technology	Ukraine
	PAC Uzbekistan Metrology, measurement technology	Uzbekistan
-	PAC China Metrology, measurement technology	China

Certificates

Certificates	
Certificates	<ul style="list-style-type: none"> ■ 2.2 test report per EN 10204 (e.g. state-of-the-art manufacturing, indication accuracy) ■ 3.1 inspection certificate per EN 10204 (e.g. material proof for wetted metal parts, indication accuracy) ■ A2LA calibration certificate, traceable and accredited in accordance with ISO/IEC 17025 ■ Calibration certificate by a national accreditation body, traceable and accredited in accordance with ISO/IEC 17025 on request
Recommended calibration interval	1 year (dependent on conditions of use)

→ Approvals and certificates, see website

Dimensions in inch [mm]

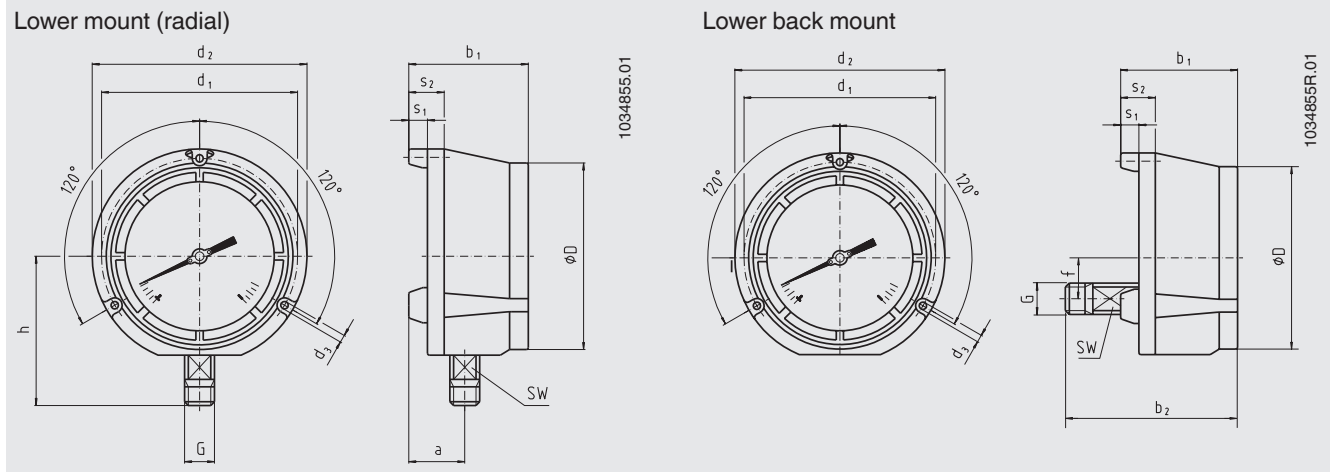

Process connection with thread per ANSI/ASME B1.20.1

NS	G	Dimensions in inch [mm]											
		a	b ₁	b ₂	D	d ₁	d ₂	d ₃	f	h	s ₁	s ₂	SW
4 ½" [115]	¼ NPT	1.57 [40]	3.31 [84]	4.49 [114]	5 [128]	5.37 [136.5]	5.83 [148]	0.248 [6.3]	1.12 [28.5]	3.91 [99]	0.49 [12.5]	0.99 [25]	0.87 [22]
	½ NPT	1.57 [40]	3.31 [84]	4.74 [120]	5 [128]	5.37 [136.5]	5.83 [148]	0.248 [6.3]	1.12 [28.5]	4.06 [103]	0.49 [12.5]	0.99 [25]	0.87 [22]
6" [160]	¼ NPT	1.58 [40.2]	3.46 [88]	4.62 [117.4]	6.46 [164]	7 [177.8]	7.5 [190]	0.28 [7.1]	1.12 [28.5]	4.58 [116.5]	0.5 [12.7]	1 [25.4]	0.87 [22]
	½ NPT	1.58 [40.2]	3.46 [88]	4.86 [123.4]	6.46 [164]	7 [177.8]	7.5 [190]	0.28 [7.1]	1.12 [28.5]	4.82 [122.5]	0.5 [12.7]	1 [25.4]	0.87 [22]

Process connection with thread per EN 837-1

NS	G	Dimensions in inch [mm]											
		a	b ₁	b ₂	D	d ₁	d ₂	d ₃	f	h	s ₁	s ₂	SW
4 ½" [115]	G ¼ B	1.57 [40]	3.31 [84]	4.49 [114]	5 [128]	5.37 [136.5]	5.83 [148]	0.248 [6.3]	1.12 [28.5]	3.82 [97]	0.49 [12.5]	0.99 [25]	0.87 [22]
	G ½ B	1.57 [40]	3.31 [84]	4.76 [121]	5 [128]	5.37 [136.5]	5.83 [148]	0.248 [6.3]	1.12 [28.5]	4.09 [104]	0.49 [12.5]	0.99 [25]	0.87 [22]
6" [160]	G ¼ B	1.58 [40.2]	3.46 [88]	4.62 [117.4]	6.46 [164]	7 [177.8]	7.5 [190]	0.28 [7.1]	1.12 [28.5]	4.58 [116.5]	0.5 [12.7]	1 [25.4]	0.87 [22]
	G ½ B	1.58 [40.2]	3.46 [88]	4.89 [124.4]	6.46 [164]	7 [177.8]	7.5 [190]	0.28 [7.1]	1.12 [28.5]	4.86 [123.5]	0.5 [12.7]	1 [25.4]	0.87 [22]

NS	Weight	
	Model 232.34	Model 233.34
4 ½" [115]	approx. 2 lbs [0.9 kg]	approx. 3 lbs [1.4 kg]
6" [160]	approx. 3 lbs [1.4 kg]	approx. 4 lbs [1.8 kg]





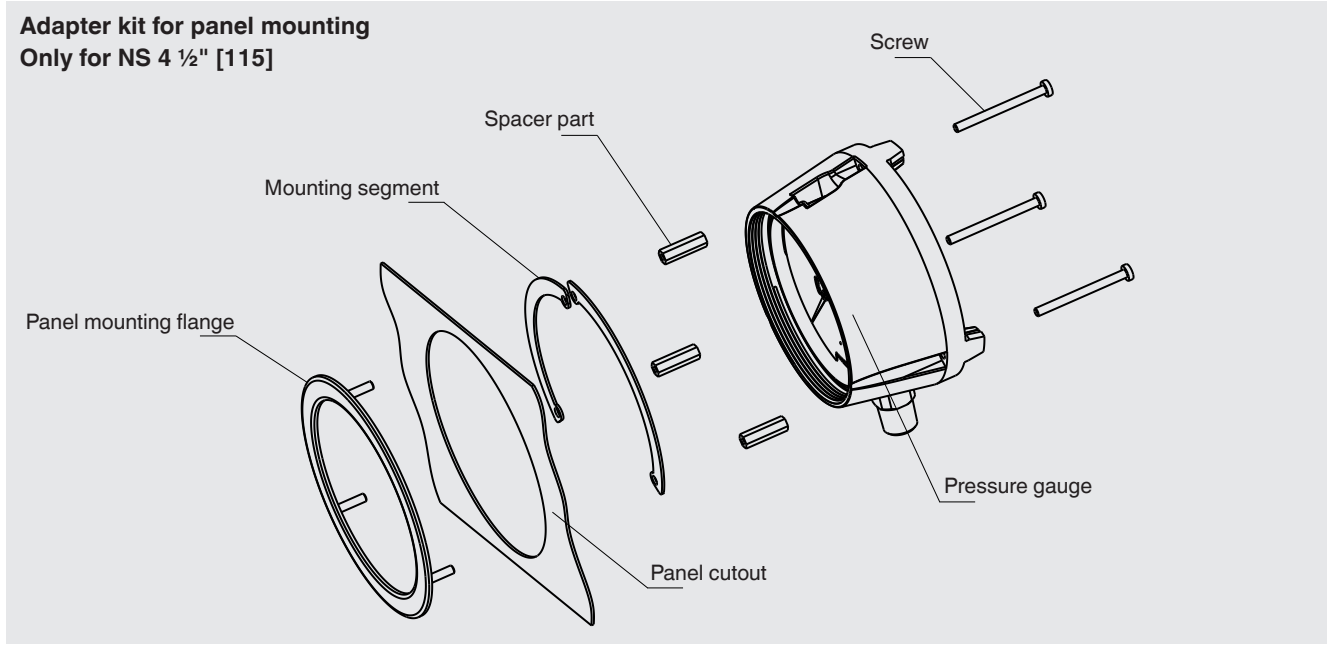



Accessories

Adapter kit for panel mounting Only for NS 4 1/2" [115]

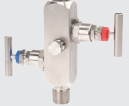

Dimensions in inch [mm]		Order number
Recommended panel cutout	Wall thickness of control panel	
Ø 5.69 [144.5]	0.063 ... 0.31 [1.5 ... 7.9]	0738581

Accessories and spare parts

Model	Description
	910.17 Seals → See data sheet AC 09.08
	910.15 Syphons → See data sheet AC 09.06
	910.13 Overpressure protector → See data sheet AC 09.04
	IV1 Needle valve and multiport valve → See data sheet AC 09.22
	IV2 Block-and-bleed valve → See data sheet AC 09.19
	IVM Monoflange, process and instrument version → See data sheet AC 09.17
	BV Ball valve, process and instrument version → See data sheet AC 09.28
	IBF2, IBF3 Monoblock with flange connection → See data sheet AC 09.25

Ordering information

Model / Nominal size / Scale range / Process connection / Connection location / Options

© 02/1995 WIKA Alexander Wiegand SE & Co. KG, alle Rechte vorbehalten.
 Die in diesem Dokument beschriebenen Geräte entsprechen in ihren technischen Daten dem derzeitigen Stand der Technik.
 Änderungen und den Austausch von Werkstoffen behalten wir uns vor.
 Bei unterschiedlicher Auslegung des übersetzten und des englischen Datenblatts ist der englische Wortlaut maßgebend.

